

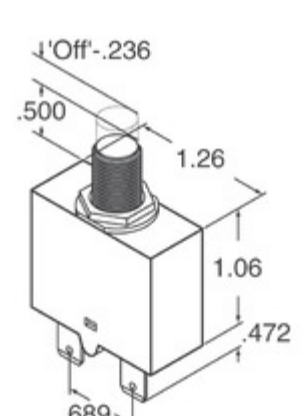

1658-G21-01-P13-20A



Images are for reference only.
See Product Specifications for product details.
Buy 1658-G21-01-P13-20A with confidence from Component-World.HK, 1 Year Warranty



















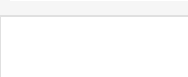

Part Number: 1658-G21-01-P13-20A
Manufacturer: E-T-A
Description: CIR BRKR THRM 20A 240VAC/28VDC
Data sheet:  [1658-G21,A00-xx-P\(10,13\)-xx Series](#)

RoHS Status: Lead free / RoHS Compliant
Ship From: Hong Kong
Shipment Way: DHL/Fedex/TNT/UPS/EMS

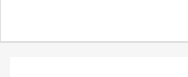
[Request For Quotation](#)

PRODUCT PARAMETER			
Part Number	1658-G21-01-P13-20A	Manufacturer	E-T-A
Description	CIR BRKR THRM 20A 240VAC/28VDC	Lead Free Status / RoHS Status	Lead free / RoHS Compliant
Quantity Available	36067 pcs	Data sheet	1658-G21,A00-xx-P(10,13)-xx Series
Category	Circuit Protection	Voltage Rating - DC	28V
Voltage Rating - AC	240V	Series	1658
Number of Poles	1	Mounting Type	Panel Mount
Moisture Sensitivity Level (MSL)	1 (Unlimited)	Manufacturer Standard Lead Time	9 Weeks
Lead Free Status / RoHS Status	Lead free / RoHS Compliant	Illumination Voltage (Nominal)	-
Illumination	-	Current Rating	20A
Breaker Type	Thermal	Actuator Type	Push to Reset

Component-World.com is a Reliable Stocking Distributor of Electronic Components. We specialize in all E-T-A series electronic components. We have 36067 pieces of E-T-A 1658-G21-01-P13-20A in stock available now. Request a quote from electronics components distributor at Component-World.com, our sales team will contact you within 24 hours. RFQ Email: info@Components-World.com

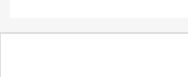
RELATED PRODUCTS			
	Part#: 1658-G21-01-S83-055809-20A Description: CIR BRKR THRM 20A 240VAC 28VDC	Manufacturers: E-T-A	RFQ
	Part#: 1658-G21-01-P13-10A Description: CIR BRKR THRM 10A 240VAC 28VDC	Manufacturers: E-T-A	RFQ
	Part#: 1658-G21-01-S83-055809-8A Description: CIR BRKR THRM 8A 240VAC 28VDC	Manufacturers: E-T-A	RFQ
	Part#: 1658-G21-01-S83-055809-15A Description: CIR BRKR THRM 15A	Manufacturers: E-T-A	RFQ
	Part#: 1658-G21-01-P10-D01-15A Description: CIR BRKR THRM 15A 240VAC 28VDC	Manufacturers: E-T-A	RFQ
	Part#: 1658-G21-01-P10-D01-20A Description: CIR BRKR THRM 20A 240VAC 28VDC	Manufacturers: E-T-A	RFQ
	Part#: 1658-G21-01-S83-055809-10A Description: CIR BRKR THRM 10A	Manufacturers: E-T-A	RFQ
	Part#: 1658-G21-01-S83-055801-15A Description: CIR BRKR THRM 15A 240VAC 28VDC	Manufacturers: E-T-A	RFQ
	Part#: 1658-G21-01-S83-055809-5A Description: CIR BRKR THRM 5A	Manufacturers: E-T-A	RFQ
	Part#: 1658-G21-01-S83-055809-12A Description: CIR BRKR THRM 12A 240VAC 28VDC	Manufacturers: E-T-A	RFQ
	Part#: 1658-G21-01-S83-055809-30A Description: CIR BRKR THRM 30A	Manufacturers: E-T-A	RFQ
	Part#: 1658-G21-01-P13-15A Description: CIR BRKR THRM 15A 240VAC 28VDC	Manufacturers: E-T-A	RFQ
	Part#: 1658-G21-01-P10-D01-25A Description: CIR BRKR THRM 25A 240VAC 28VDC	Manufacturers: E-T-A	RFQ
	Part#: 1658-G21-01-P10-D01-7A Description: CIR BRKR THRM 7A 240VAC 28VDC	Manufacturers: E-T-A	RFQ
	Part#: 1658-G21-01-P10-D01-30A Description: CIR BRKR THRM 30A 240VAC 28VDC	Manufacturers: E-T-A	RFQ
	Part#: 1658-G21-01-P13-055800-8A Description: CIR BRKR THRM 8A 240VAC/28VDC	Manufacturers: E-T-A	RFQ
	Part#: 1658-G21-01-P13-D01-20A Description: CIR BRKR THRM 20A 240VAC/28VDC	Manufacturers: E-T-A	RFQ
	Part#: 1658-G21-01-P10-D01-5A Description: CIR BRKR THRM 5A 240VAC 28VDC	Manufacturers: E-T-A	RFQ
	Part#: 1658-G21-01-S83-055801-20A Description: CIR BRKR THRM 20A 240VAC 28VDC	Manufacturers: E-T-A	RFQ
	Part#: 1658-G21-01-P10-D04-8A Description: CIR BRKR THRM 8A 240VAC 28VDC	Manufacturers: E-T-A	RFQ

Related keywords for **1658-G21-01-P13-20A**

E-T-A 1658-G21-01-P13-20A	1658-G21-01-P13-20A distributor	1658-G21-01-P13-20A supplier	1658-G21-01-P13-20A price
1658-G21-01-P13-20A download datasheet	1658-G21-01-P13-20A datasheet	1658-G21-01-P13-20A stock	buy 1658-G21-01-P13-20A
E-T-A 1658-G21-01-P13-20A			

